

CANDIDATE
NAME

--

CENTRE
NUMBER

--	--	--	--	--

CANDIDATE
NUMBER

--	--	--	--

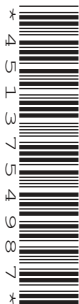

COMPUTER STUDIES

7010/13

Paper 1

October/November 2014

2 hours 30 minutes

Candidates answer on the Question Paper.

No Additional Materials are required.

READ THESE INSTRUCTIONS FIRST

Write your Centre number, candidate number and name on all the work you hand in.

Write in dark blue or black pen.

You may use an HB pencil for any diagrams, graphs or rough working.

Do not use staples, paper clips, glue or correction fluid.

DO NOT WRITE IN ANY BARCODES.

Answer **all** questions.

No marks will be awarded for using brand names of software packages or hardware.

At the end of the examination, fasten all your work securely together.

The number of marks is given in brackets [] at the end of each question or part question.

This document consists of **22** printed pages and **2** blank pages.

1 Give, with reasons, **three** safety issues associated with the use of computers in the office.

1

.....

.....

2

.....

.....

3

.....

..... [3]

2 In the diagram below, there are **two** types of memory shown on the left and **five** typical memory features shown on the right.

Link each feature to **either** RAM **or** ROM by drawing connecting lines.

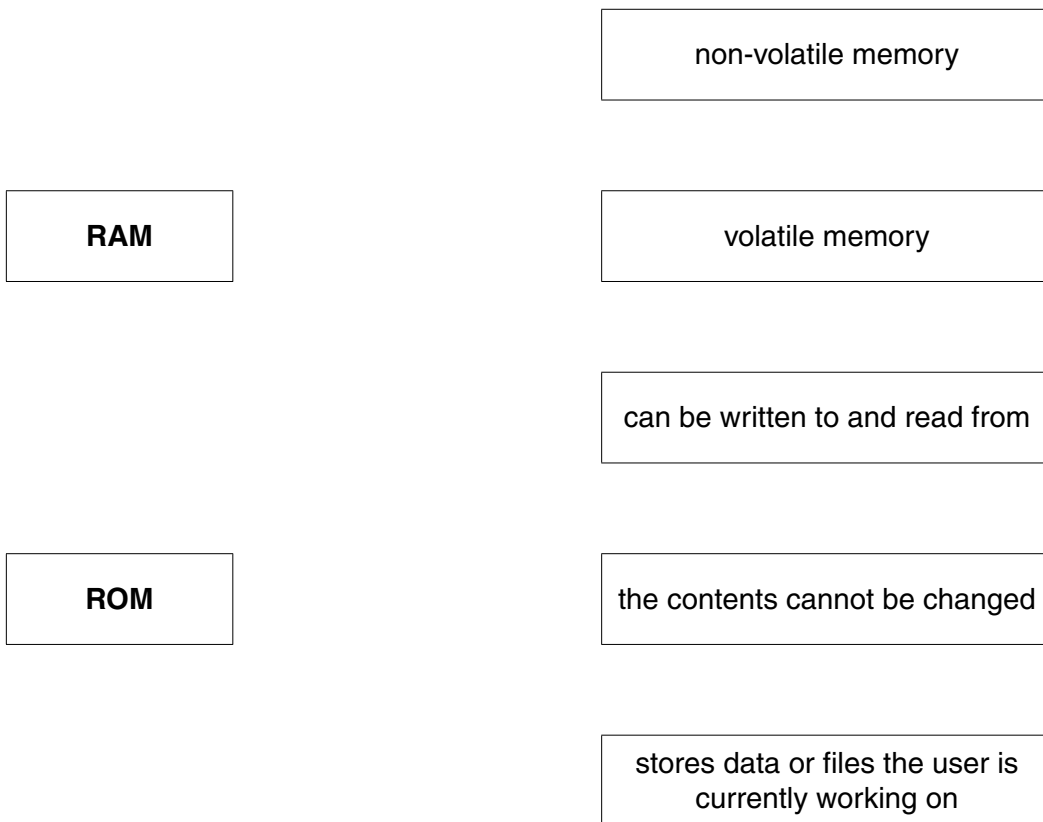

[5]

3 (a) Felipe wrote down the following three statements.

In **each** case, indicate whether the statement is true or false and give a reason for your choice.

“encrypting data prevents it from being hacked”

TRUE/FALSE

Reason

.....
.....

“backing up data removes the risk of the data being infected by viruses”

TRUE/FALSE

Reason

.....
.....

“wireless (WiFi) networks are less secure than hard-wired systems”

TRUE/FALSE

Reason

.....
.....

[3]

(b) Felipe uses Internet banking. When he logs on, the website asks for the 1st, 4th and 8th characters in his password. He selects the characters from drop-down boxes.

(i) State why drop-down boxes are used.

.....
..... [1]

(ii) Felipe is also asked to confirm the last date and time when he logged onto the website.

State why he is asked to confirm this.

.....
..... [1]

- (iii) When Felipe wishes to return to a previous page on this website, he clicks on the **View My Account** option rather than using the browser arrows. If he uses the browser arrows, he is logged out of the website.

Give a reason why the website does this.

.....
.....
.....[1]

- 4 Rikki uses an expert system, installed on her laptop computer, to trace faults in television sets. She visits a customer and tries to locate the problem using the expert system.

- (a) Explain how Rikki and the expert system will interact to help diagnose the fault in the television.

.....
.....
.....
.....
.....
.....
.....
.....[3]

- (b) The expert system requires certain files to be stored on a memory stick (or USB flash drive) that must be connected to the laptop for the software to work.

Give **two** possible reasons why these extra files are stored on the memory stick.

1

.....

2

.....[2]

- (c) Give an example of the use of an expert system other than fault diagnosis.

.....
.....[1]

5 Six statements and six values are shown below.

Each statement will generate one possible value.

Draw a line to link each statement to its correct value.

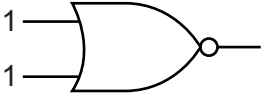
statement	value						
number of possible binary input combinations for a 2-input logic gate circuit	0						
output from the logic gate: 	1						
base 10 (denary) value of the following binary number: <table border="1" data-bbox="440 1012 632 1079"> <tr> <td>4</td> <td>2</td> <td>1</td> </tr> <tr> <td>1</td> <td>1</td> <td>0</td> </tr> </table>	4	2	1	1	1	0	4
4	2	1					
1	1	0					
what is the output from the algorithm: $y = 1$ for $x = 1$ to 4 $y = y * x$ next x print y	6						
number of bytes formed from 8 bits	20						
If there are 2^x bytes in a Mbyte, what is the value of X?	24						

[5]

6 The following pseudocode algorithm should:

- input up to 20 numbers
- stop if the sum of the input numbers **exceeds** 50
- output the final sum

```
10 count = 0
20 REPEAT
30     INPUT n
40     n + sum = sum
50     IF sum = 50 THEN count = 20
60     count = count + 1
70 UNTIL count = 20
80 OUTPUT n
```

There are **five** errors in this algorithm.

Locate these errors and suggest a correction.

error 1

correction

.....

error 2

correction

.....

error 3

correction

.....

error 4

correction

.....

error 5

correction

.....[5]

7 The following **five** statements about the Internet are incomplete:

- (i) < - - - - **(a)** - - - - > includes software that allows users to create and edit web pages using a browser. Anyone is able to create or edit this information.
- (ii) < - - - - **(b)** - - - - > allow interaction of people online. Users can add friends, post messages and update their personal profiles to notify friends about their status.
- (iii) A series of digital media files that are released at regular intervals and downloaded to the user's computer are known as < - - - - **(c)** - - - - >. These media files are stored and maintained centrally.
- (iv) < - - - - **(d)** - - - - > is a type of bookmarking where a user "marks" a webpage or photo using text to describe its contents. Anyone can view the webpages or photos corresponding to these "markers".
- (v) Internet journals where a writer enters text about a particular topic or person are known as < - - - - **(e)** - - - - >.

Complete the five statements above using terms from the following list:

- blogs
- data (bit) streaming
- Internet service provider
- podcasts
- social networking sites
- tagging
- web browser
- wikis

- (a)[1]
- (b)[1]
- (c)[1]
- (d)[1]
- (e)[1]

- 8 Data sent across the Internet are frequently encrypted. The following flowchart shows a basic encryption method (Note: the \rightarrow symbol in the flowchart means “is replaced by”).

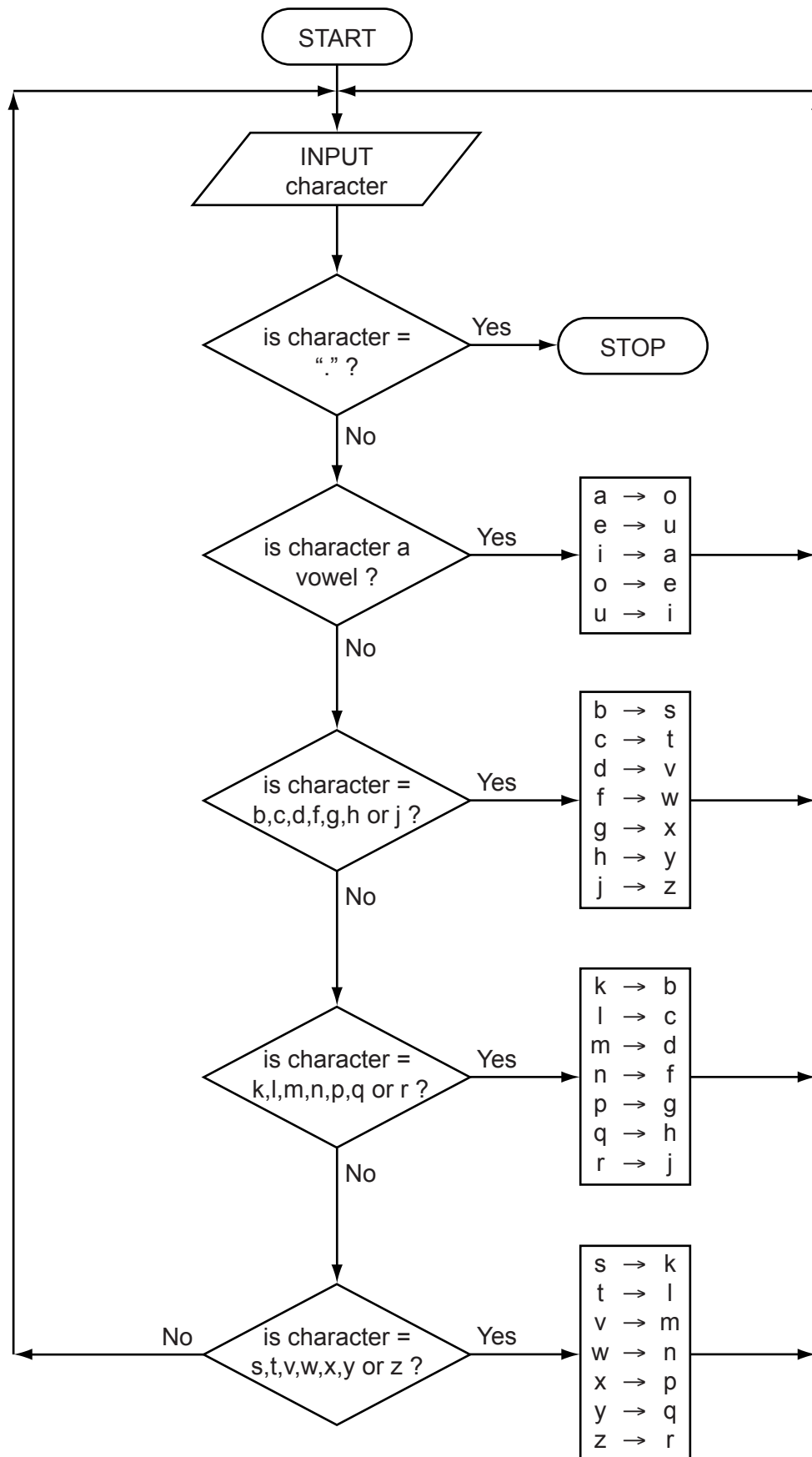

For example,

h e l l o i a m a r o b o t .

becomes:

y u c c e a o d o j e s e l .

(a) Use the flowchart to encrypt the following message:

m e e t i n g w i l l g o a h e a d .

□ □ □ □ □ □ □ □ □ □ □ □ □ □ □ □ □ □ □ □

[2]

(b) Use the information in the flowchart to show which input message produced the following encrypted message:

t e d g i l a f x a k w i f .

□ □ □ □ □ □ □ □ □ □ □ □ □ □

[2]

(c) Many customers shop online.
Apart from encryption, describe **three** other security features built into many online shopping websites.

- 1
-
- 2
-
- 3
- [3]

9 A cinema (movie theatre) uses automatic machines to allow customers to select tickets for movie shows. Payments are made by credit or debit card.

(a) Identify **two** input devices which could be used by the cinema.

For **each** device, describe what it is used for.

input device 1

use

.....

.....

input device 2

use

.....

.....[4]

(b) Identify **two** output devices which could be used by the cinema.

For **each** device, describe what it is used for.

output device 1

use

.....

.....

output device 2

use

.....

.....[4]

10 A microwave oven cooks food when the food is placed on a rotating plate and the door is closed. The oven is controlled by a microprocessor.

(a) Name **two** sensors that could be used in the microwave oven.

1

2 [2]

(b) Describe **two** items of data that the user would need to input before pressing the start button.

Describe how these data could be input.

data 1

.....
.....

method of input 1

.....
.....

data 2

.....
.....

method of input 2

.....
..... [4]

(c) Describe the role of the microprocessor in the microwave oven.

.....
.....
.....
.....
.....
.....
.....
..... [4]

11 An algorithm has been written to input six temperatures for every day of the year (365 days). The outputs are:

- the average daily temperature for each day
- the highest recorded temperature for the whole year

The algorithm is in the form of a flowchart on the next page. However, several of the statements are missing.

Using instruction number **only**, complete the flowchart using the following list of instructions:

Instruction number	Instruction
1	average = total / 6
2	day = day + 1
3	high = -200
4	high = temperature
5	input temperature
6	is reading \leq 6 ?
7	is temperature $>$ high ?
8	output average
9	output high
10	reading = reading + 1
11	total = 0
12	total = total + temperature

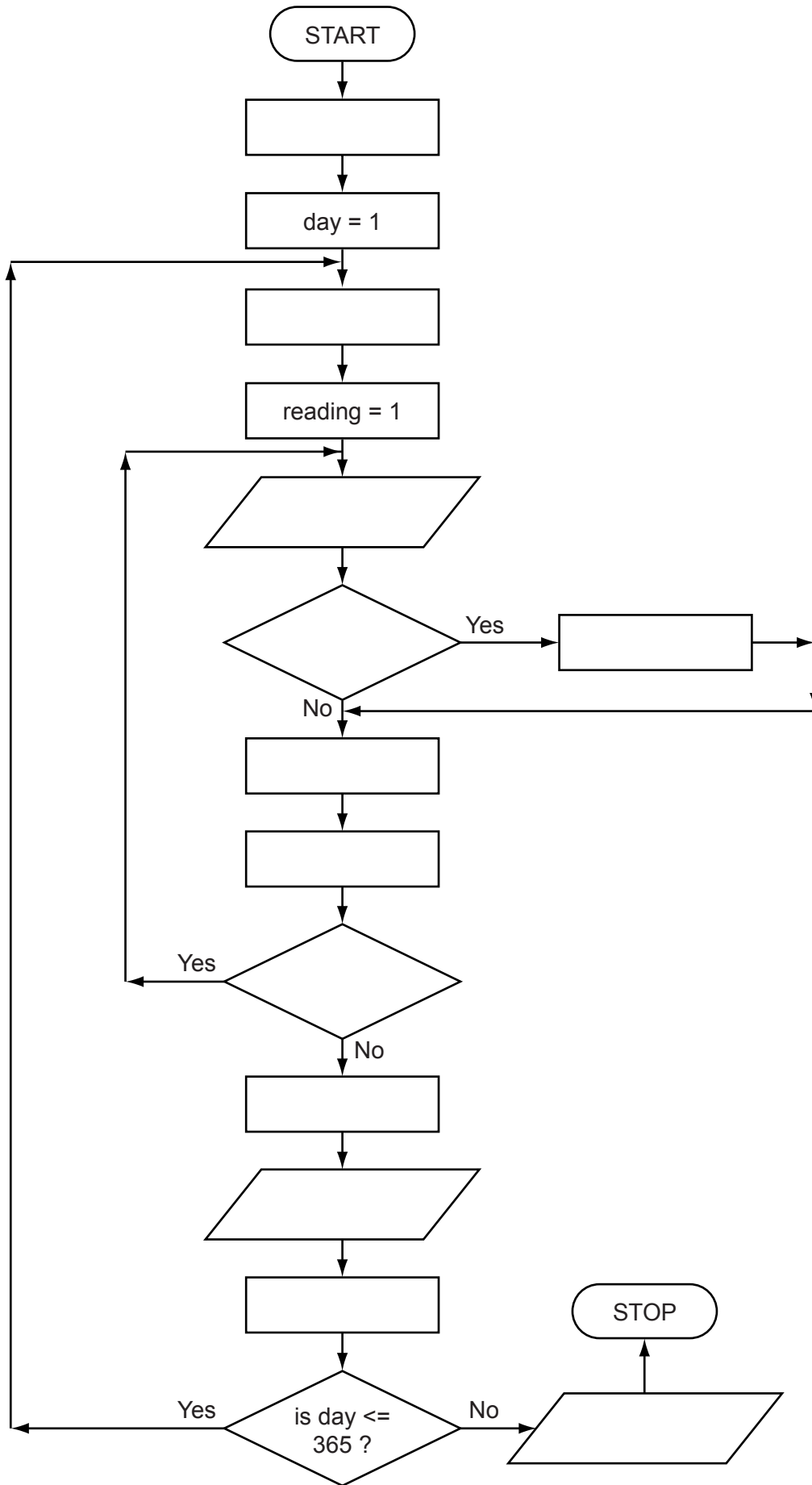

[6]

12 A spreadsheet has been set up to allow a motorist to keep a check on his fuel costs.

	A	B	C	D
1				
2	input number of litres of fuel used			
3	input number of km driven			
4	calculated fuel consumption			
5	input number of km driven each year			
6	calculated annual fuel cost			

Data are input into cells B2, B3 and B5 and results appear in cells C4 and C6.

- (a) (i) Fuel consumption is calculated as kilometres per litre.
Give the formula you would expect to see in C4.

=

- (ii) Assume that fuel costs \$2.00 per litre.
Give the formula you would expect to see in cell C6.

= [2]

- (b) It was decided to include an extra input in D1. The value input is the motorist's fuel allowance (in \$) for the year.

Cell D6 will show whether the calculated annual fuel cost is above the annual fuel allowance or not.

Complete the following formula which must be in D6:

= IF (....., ".....", "equal or below") [2]

- (c) Identify which cells would be automatically updated if the value in cell B3 was changed.

.....

..... [1]

Question 13 begins on page 16.

13 Study the following flowchart very carefully.

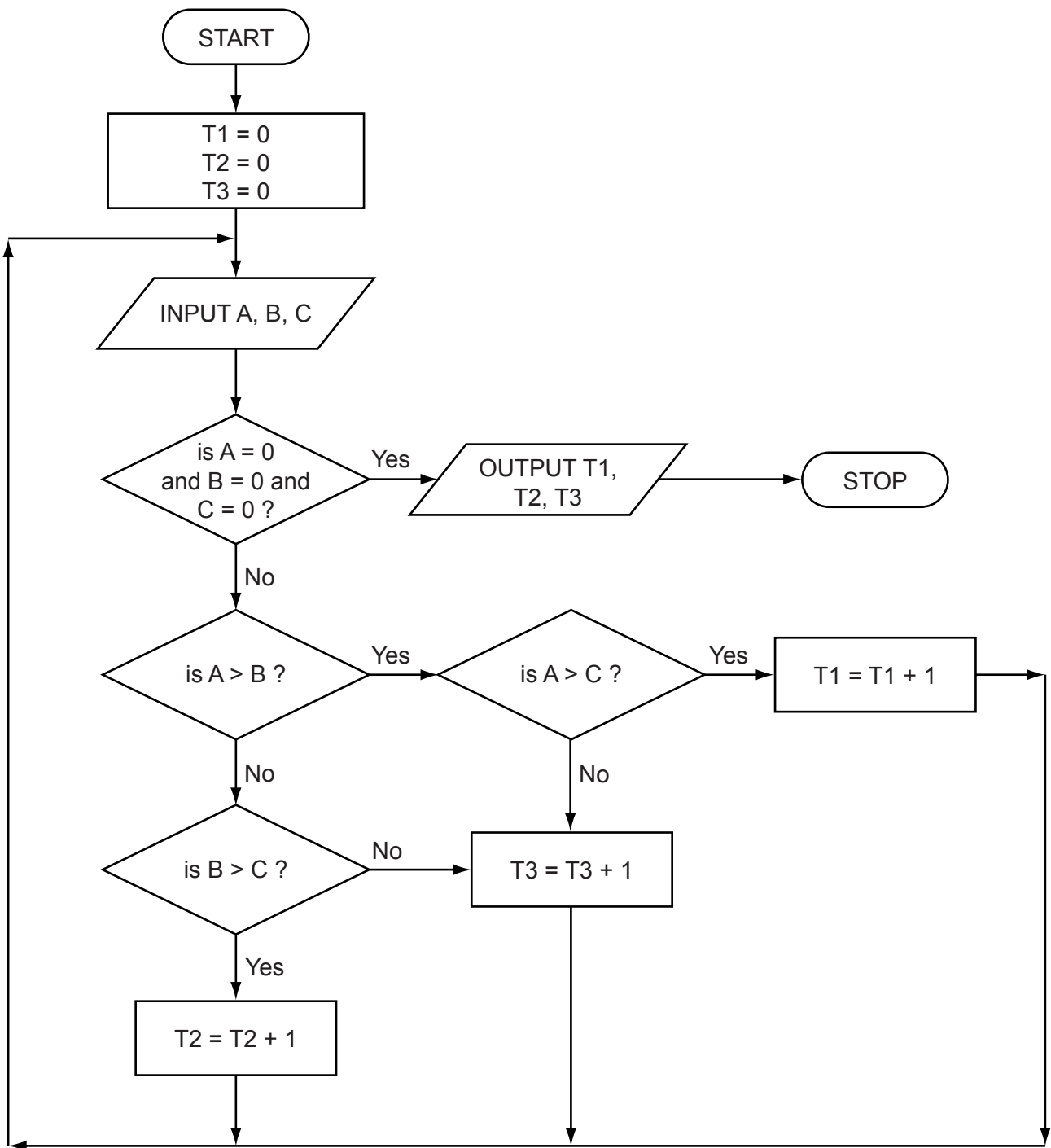

14 Digits on an electronic display board can be represented on a 7 × 5 grid. For example, the digit 3 is represented as:

	1	2	3	4	5
Row 1		■	■	■	
Row 2	■				■
Row 3					■
Row 4			■	■	
Row 5					■
Row 6	■				■
Row 7		■	■	■	

Each column in the grid is represented in a computer as a 7-bit register. Five registers are required to represent the state of the whole digit. The value 1 represents a shaded square and the value 0 represents an unshaded square. For example, the digit 3 is represented as:

Row number:	1	2	3	4	5	6	7
Register 1	0	1	0	0	0	1	0
Register 2	1	0	0	0	0	0	1
Register 3	1	0	0	1	0	0	1
Register 4	1	0	0	1	0	0	1
Register 5	0	1	1	0	1	1	0

(a) Show the contents of the five 7-bit registers when representing the digit 9:

	1	2	3	4	5
1		■	■	■	
2	■				■
3					■
4		■	■	■	
5				■	
6			■		
7		■			

→

Row number:	1	2	3	4	5	6	7
Reg 1							
Reg 2							
Reg 3							
Reg 4							
Reg 5							

[4]

(b) In order to prevent errors, an 8-bit register is used. The 8th bit will contain:

- 0 – if the first 7 bits add up to an even number
- 1 – if the first 7 bits add up to an odd number

Complete the 8th bit for each register. The first register has been completed for you.

	1	2	3	4	5	6	7	8
Reg 1	0	1	0	0	0	1	0	0
Reg 2	1	0	0	0	0	0	1	
Reg 3	1	0	0	1	0	0	1	
Reg 4	1	0	0	1	0	0	1	
Reg 5	0	1	1	0	1	1	0	

[3]

15 (a) Complete the truth table for the following logic circuit:

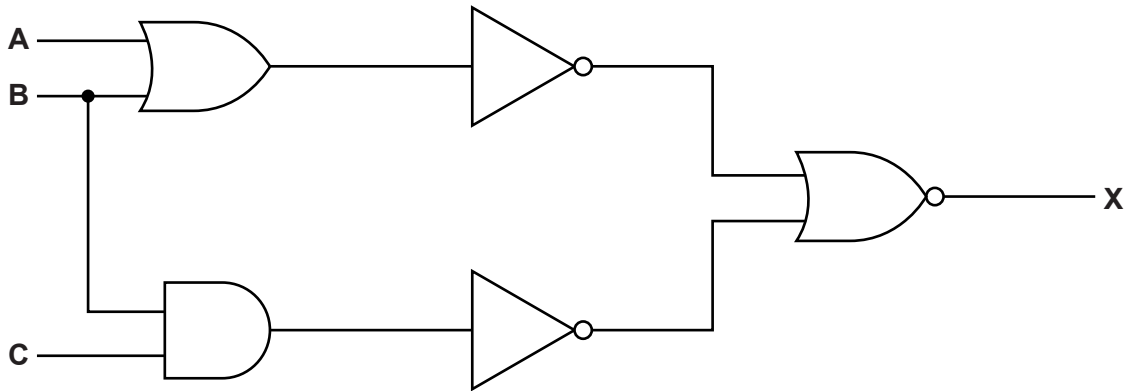

A	B	C	Working	X
0	0	0		
0	0	1		
0	1	0		
0	1	1		
1	0	0		
1	0	1		
1	1	0		
1	1	1		

[4]

(b) Re-draw the logic circuit shown opposite, using NAND and NOR gates only.

[2]

(c) Write a logic statement that describes the following logic circuit:

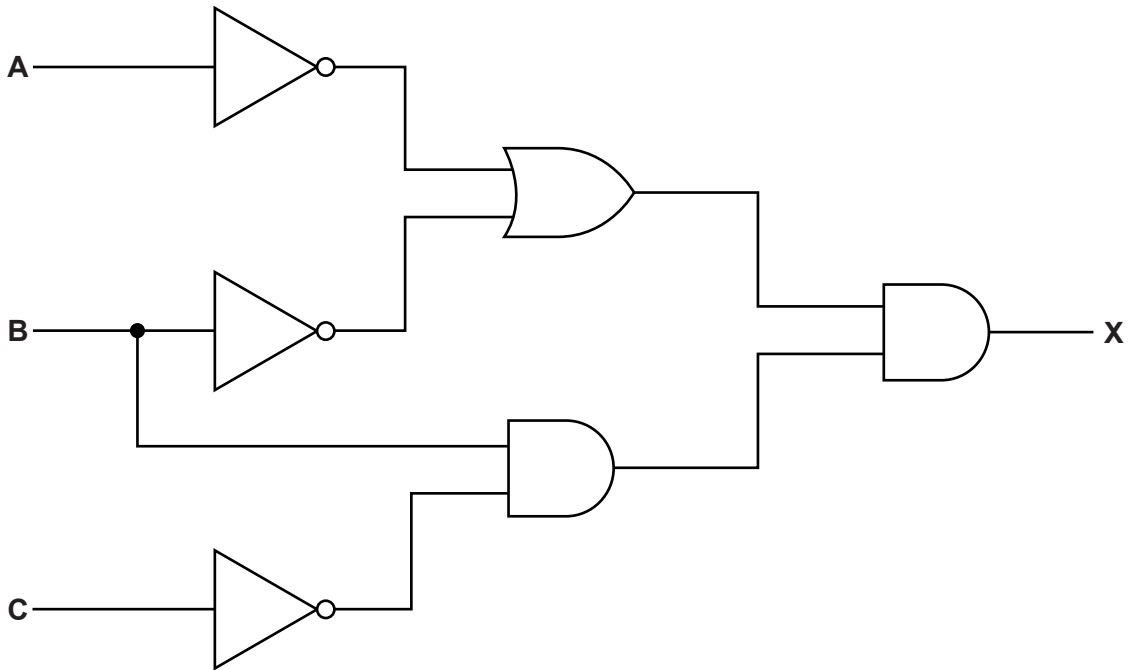

.....

.....

.....

.....

.....

.....

.....

.....

[3]

Permission to reproduce items where third-party owned material protected by copyright is included has been sought and cleared where possible. Every reasonable effort has been made by the publisher (UCLES) to trace copyright holders, but if any items requiring clearance have unwittingly been included, the publisher will be pleased to make amends at the earliest possible opportunity.

Cambridge International Examinations is part of the Cambridge Assessment Group. Cambridge Assessment is the brand name of University of Cambridge Local Examinations Syndicate (UCLES), which is itself a department of the University of Cambridge.